

BOTTOM VIEW

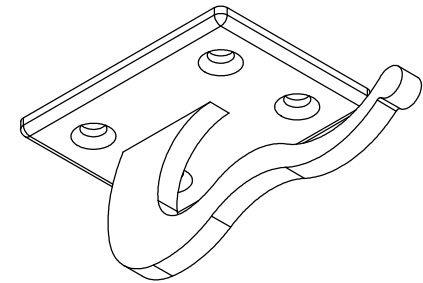

NOTES:

1. Weight Capacity: 20 lbs.

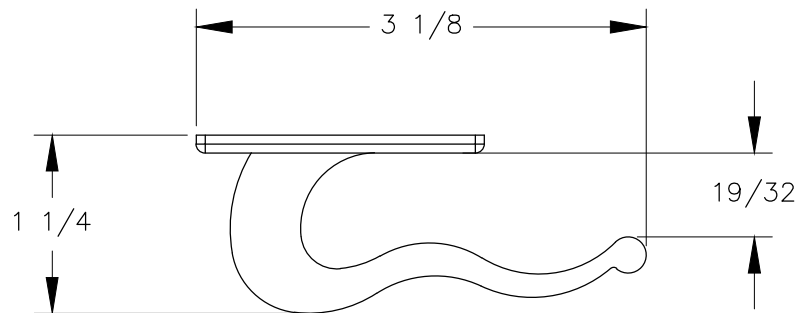

FRONT VIEW

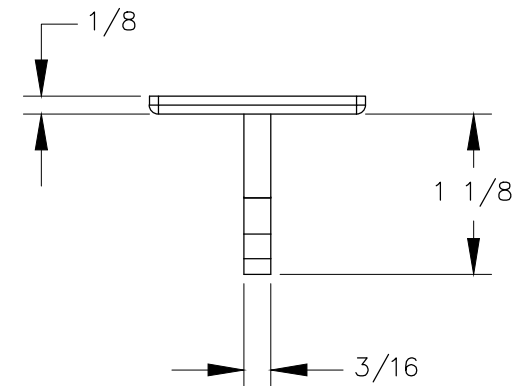

RIGHT VIEW