

Note: Go to www.mockett.com/usb for a complete list of compatible PCS units.

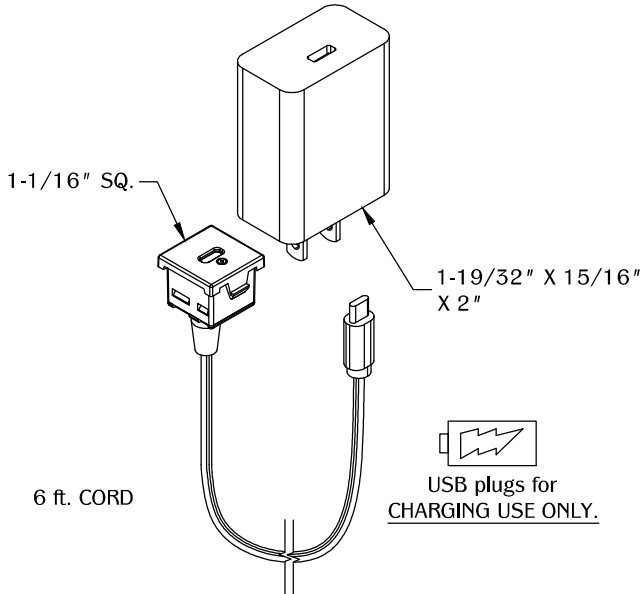

2

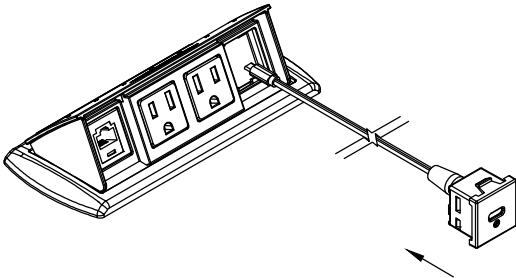

Guide the end of the power adapter that connects to the USBC/PWR through the opening.

4

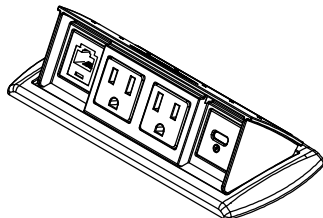

Connect the adapter to an electrical outlet. Do not place unit where cable is strained or trapped.

1

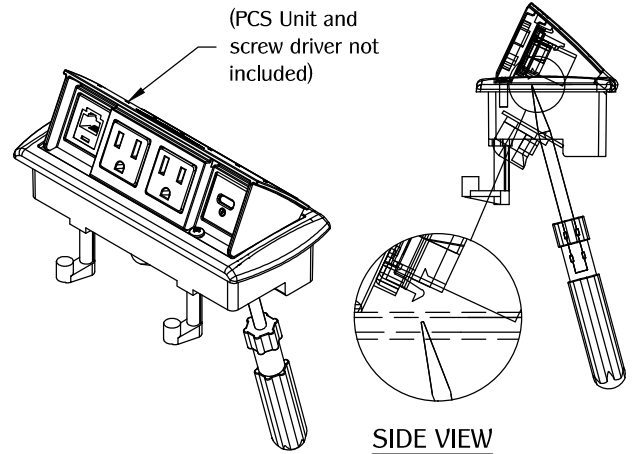

Note: Power receptacles can not be removed.

If unit is already loaded, remove one of the data inserts as follows. Otherwise proceed to Step 2. Use a flat head screw driver from the bottom and push the tab to release data insert.

3

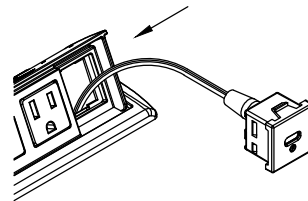

Connect the power plug into the USBC/PWR. Snap the assembly back to the PCS unit bezel.

TABLE OF CONTENTS:

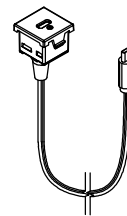

..... USBC/PWR INSERT

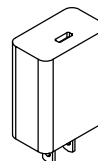

..... 1 X AC Adapter
OUTPUT: 5V - 3A
OUTPUT: 9V - 2A