

**NOTE:**

- Weight capacity is 25 lbs. MAX. per set.
- Shelf projection is 12" MAX.
- 1/4" MIN. to 1/2" MAX. shelf thickness.

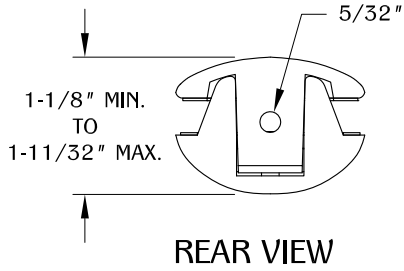

**1**

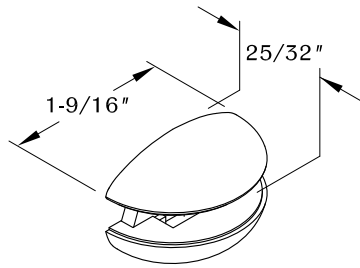
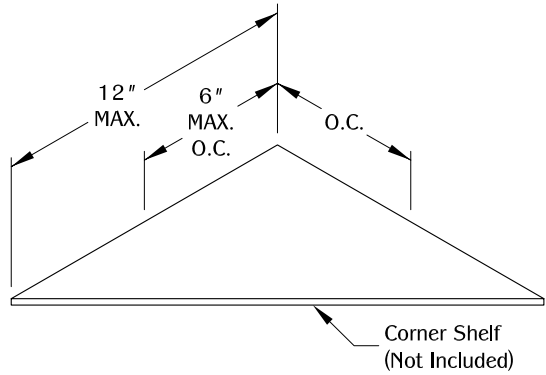

**Note:** Recommended to mount into wall studs.

Use corner shelf to determine O.C. for shelf brackets. The O.C. will be from the back corner of the shelf to the center point of the sides as displayed.

**2**

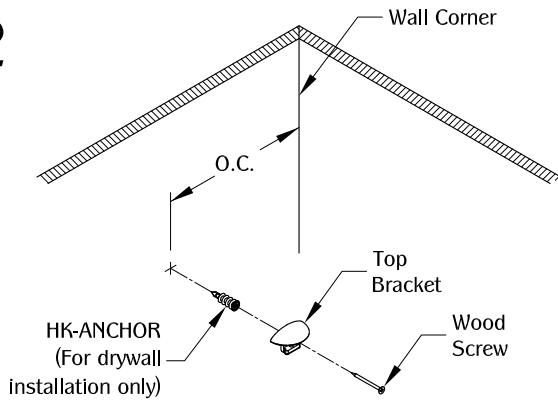

Install the top bracket of the SH7A. Make sure the part is leveled and aligned straight. Then, secure the part by using the provided mounting hardware. Repeat step on adjacent wall for the second bracket.

**3**

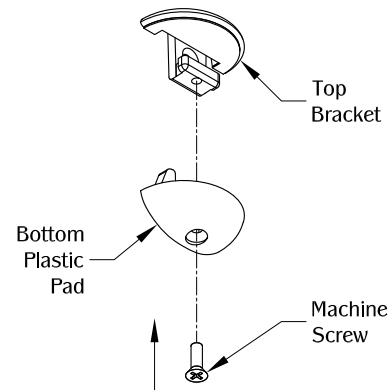



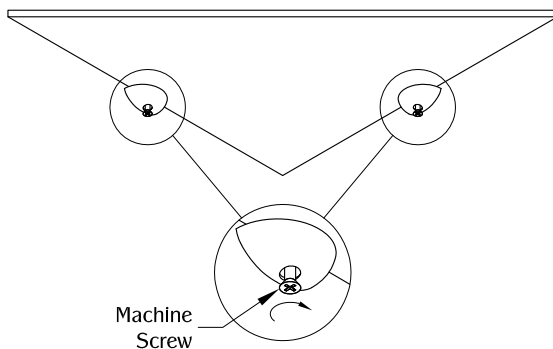

Align the brackets accordingly and secure the part with the machine screw. Repeat step for the other shelf bracket.

**4**



Install and secure the shelf by tightening the machine screw at the bottom of the brackets.

**TABLE OF CONTENTS:**

	.....	2X SH7A
	.....	2X M5 -.8 Thread Machine Screw
	.....	2X 1-1/2" No. 8 Wood Screws
	.....	2X Plastic Anchor (Not Required for Install)
	.....	2X HK-ANCHOR