

FRONT VIEW

1

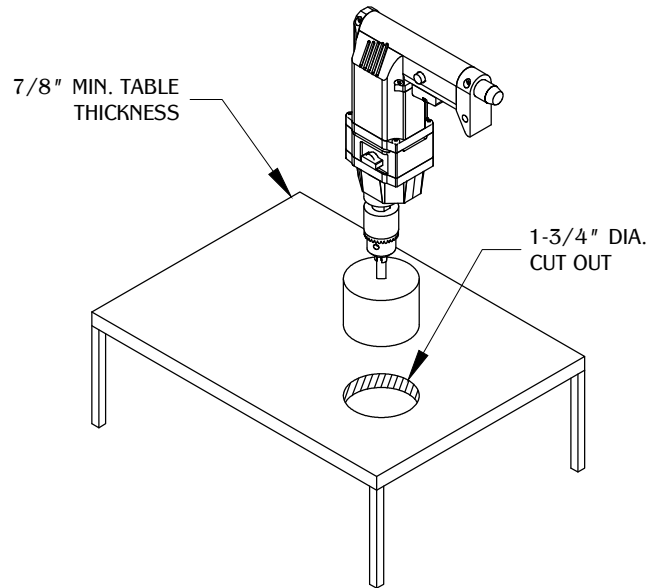

Make a cut out on the desired surface. (Note: We do not recommend cutting before receiving part or part sample.)

2

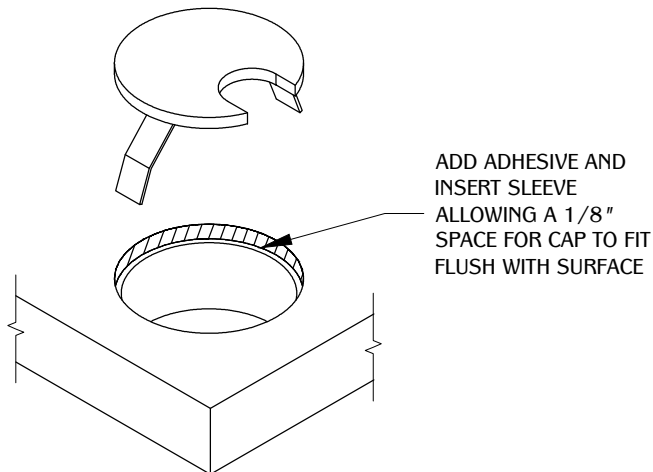

3

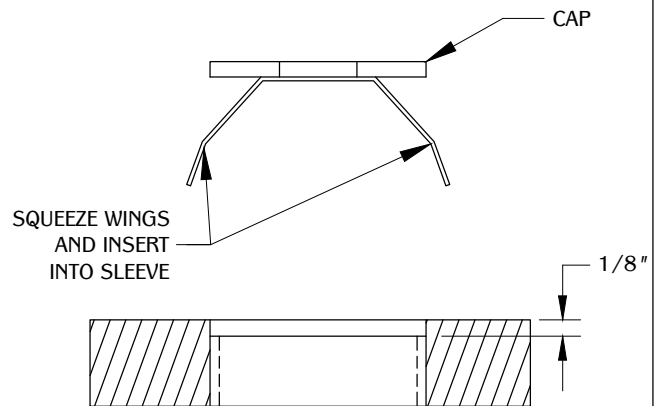

4

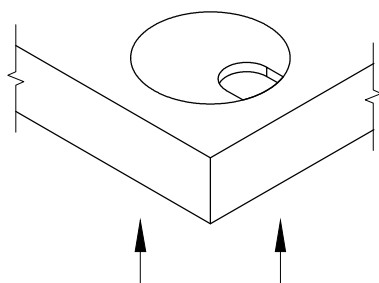

NOTE: IN ORDER TO REMOVE STEEL CAP YOU WOULD NEED TO PUSH FROM THE BOTTOM UP.

TABLE OF CONTENTS:

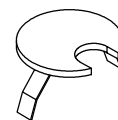

..... 1X PS-1B CAP



..... 1X PS-1B SLEEVE