

NOTE:

- Panel thickness is 6.00mm (1/4") MIN. to 8.00mm (5/16") MAX.
- Maximum panel width is 1500.00mm (59-1/16").
- Maximum panel height is 1000.00mm (39-3/8").
- Panel grip spacing is 10" from the edge.

1

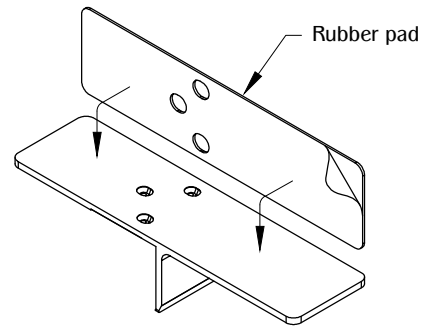

Peel the adhesive film off rubber pad and stick on to the bottom of the large panel grip. Make sure its centered.

2

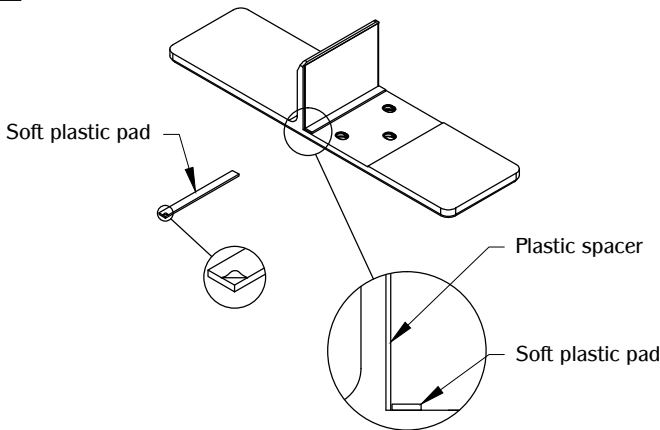

Place the spacer on the inside wall of the large panel grip. Peel the adhesive film off the soft plastic pad and stick next to the plastic spacer. Make sure it is centered.

3

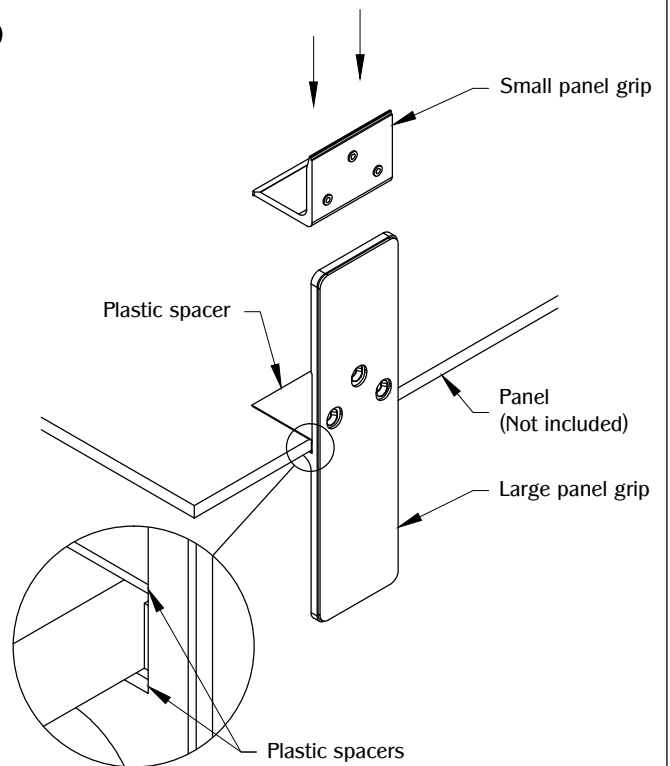





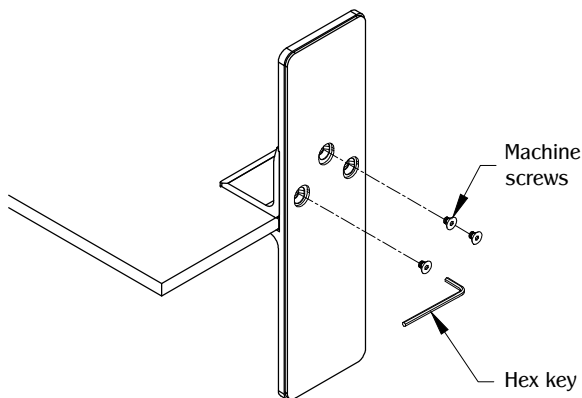

Place panel on work table, then place large panel grip on the bottom including plastic spacer (1 additional plastic spacer for use as needed). Then slide small panel grip from the top including plastic spacer.

4

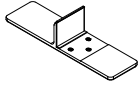

Squeeze panel grips and Secure the panel using (3) machine screws. Repeat steps as needed for additional panel grips.

TABLE OF CONTENTS:

	1X 3.00mm Hex key
	1X PGRP11 Large panel grip
	1X PGRP11 Small panel grip
	3X Plastic spacers
	1X Rubber pads
	3X 1/4" Hex screws M5-.8 Thread
	1X Soft plastic pads