

PART #

PCS36A-U

310.318.2491 • 800.523.1269 • www.mockett.com

NOTE:

PLEASE USE APPLICABLE ADAPTER FROM DATA TREE. (SEE PCS DATA TREE PAGE FOR MORE INFORMATION.)

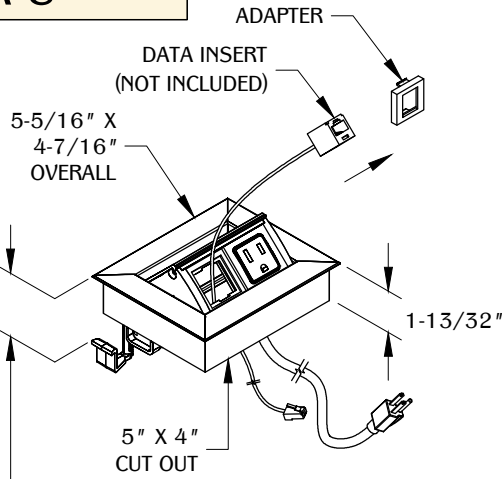
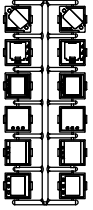

3/4" MIN.
1-11/16" MAX
TABLE THICKNESS

NOTE:
Please **DO NOT**
remove tape!

1

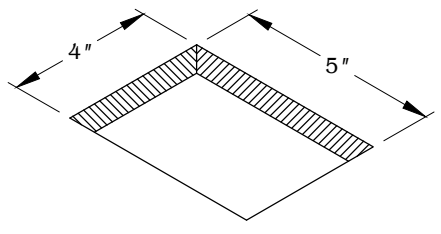

Make a cut out of 5" X 4" at the desired surface.

2

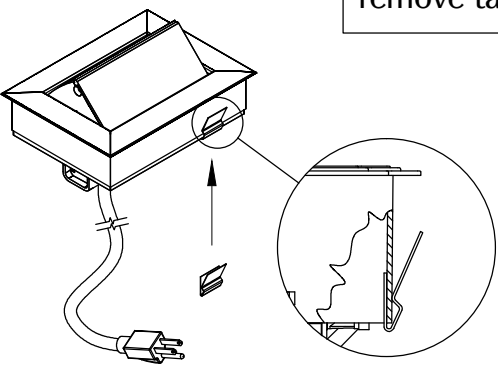

Place metal clips near the ends of the back of the unit.
(NOTE: Metal clips are for use in hard surface material only as an optional mounting means.)

3

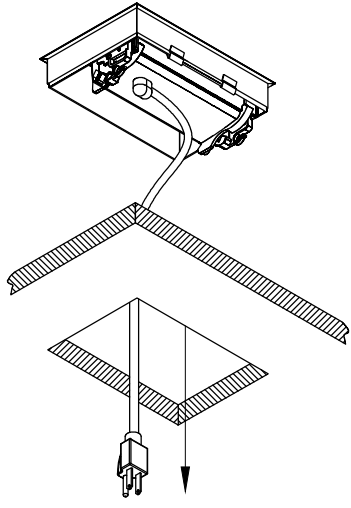

Drop in unit into cut out.

4

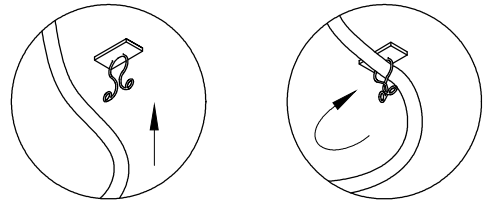

Optional wire manager.

5

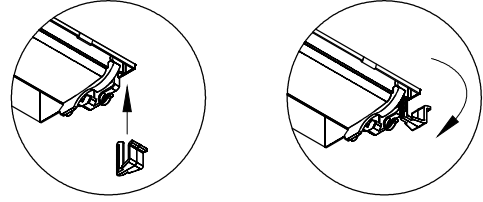

Secure unit by turning bottom wing clamp.

TABLE OF CONTENTS:

1 X PCS36A-U (1 POWER)
1 X WIRE MANAGER
2 X METAL CLIPS
2 X WING CLAMP

PCS Data Tree

- 1.) Select the appropriate adapter from the chart below. (example: Panduit Mini-Com Series jack would use "FFF" adapter marked on back of adapter.)

*Jacks, not included, UL Listed (DUXR) or Recognized (DUXR2) jacks required.

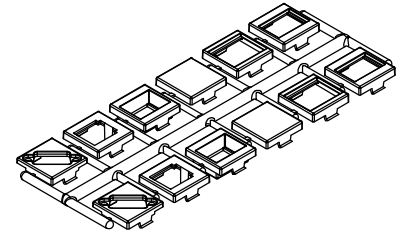

Adapter	Manufacturer	Website
BBB	L-Com Keystone Modular	www.L-Com.com
BBB	NETCONNECT, and 110 Connect Series Modular Jack	www.Anixter.com
BBB	Siemon ZMAX Style	www.Siemon.com
BBB	Allen Tel Versa Tap Series	www.Graybar.com
BBB	Leviton Quick Port ® Series	www.Leviton.com
BBB	Belden REVConnect	www.Belden.com
BBB	HDMI Adapter Cable	www.Mockett.com
CCC	Hubbell Nextspeed™ Keystone Series	www.Hubbell-premise.com
CCC	ADC Truenet Series	www.Anixter.com
DDD	Blank (no coupler/jack)	-
EEE	Ortronics TracJack Series	www.Ortronics.com
FFF	Panduit Mini-Com Series	www.Panduit.com
HHH	Video Monitor Jack/DB-15, panel mount solder style	www.Mockett.com

- 2.) Snap Jack into adapter following the instructions provided with the jack.
- 3.) Once assembled, snap adapter into the notched, square holes in the orientation shown.

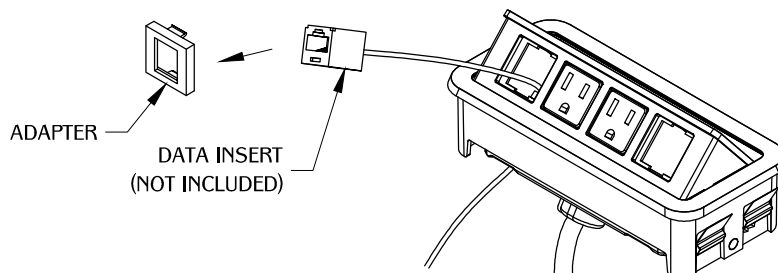

NOTE: Please verify fit of jack in adapter before ordering large quantities as manufacturer designs may change without notice.