

1

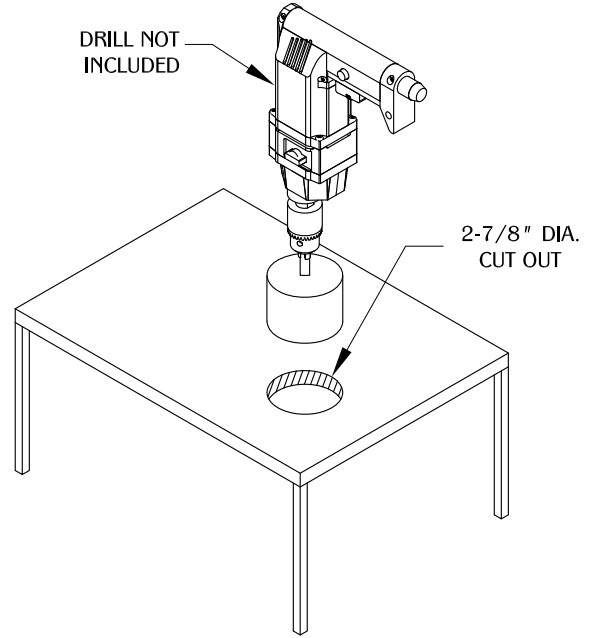

2

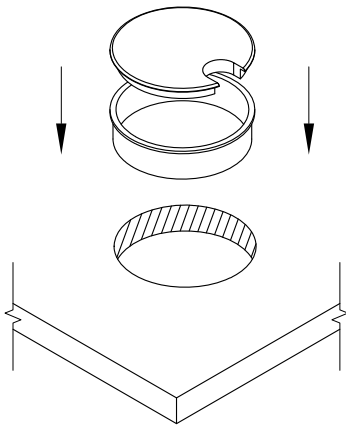

3

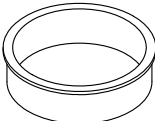

TABLE OF CONTENTS:

 1 X MM5
 1 X MM5A

* ALL DIMENSIONS HAVE A +/- 1/32" TOLERANCE UNLESS OTHERWISE SPECIFIED. WE DO NOT RECOMMEND DRILLING OR CUTTING ANY HOLES BEFORE RECEIVING A PRODUCT OR A PRODUCT SAMPLE. ALL MEASUREMENTS ARE IN INCHES.