

1

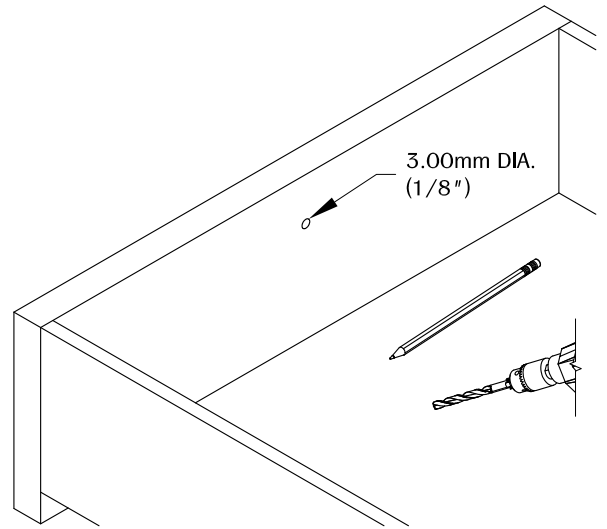

2

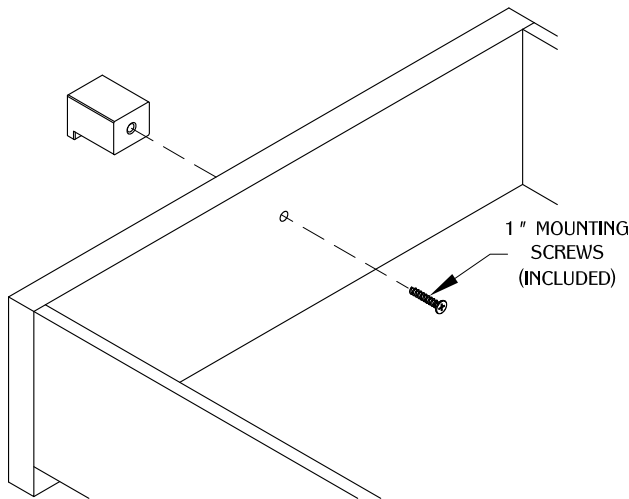

3

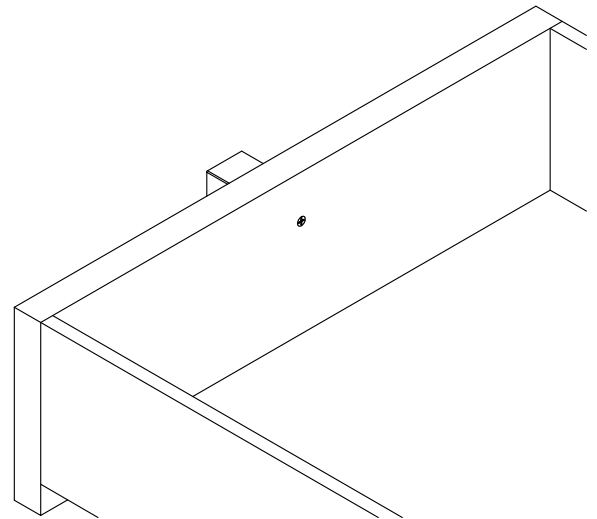

Note: Additional screw sizes available upon request (3/4" up to 2" in 1/4" increments).

NOTE:
ALL DIMENSIONS HAVE A + / - 1/32" TOLERANCE.
WE DO NOT RECOMMEND DRILLING OR CUTTING ANY HOLES BEFORE RECEIVING A PRODUCT OR A PRODUCT SAMPLE.

TABLE OF CONTENTS:

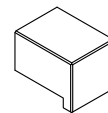

..... 1x DP197



..... 1x MOUNTING SCREWS