

1

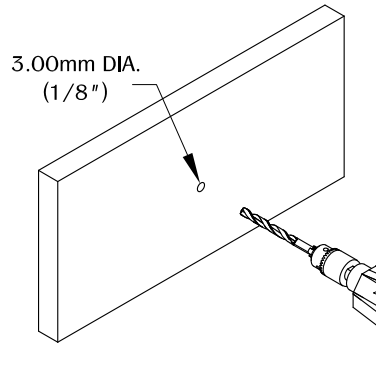

2

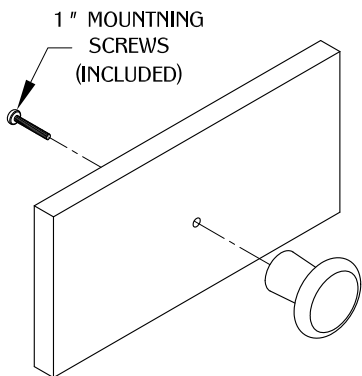

3

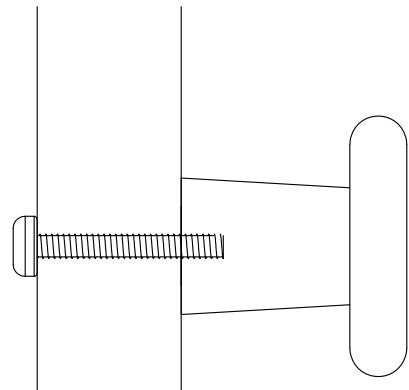

NOTE: Additional screw sizes available upon request (3/4" up to 2" in 1/4" increments).

4

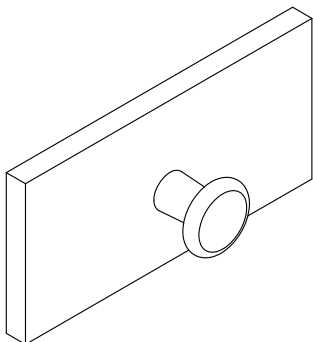



TABLE OF CONTENTS:

 DP196
 1X MOUNTING SCREWS