

1

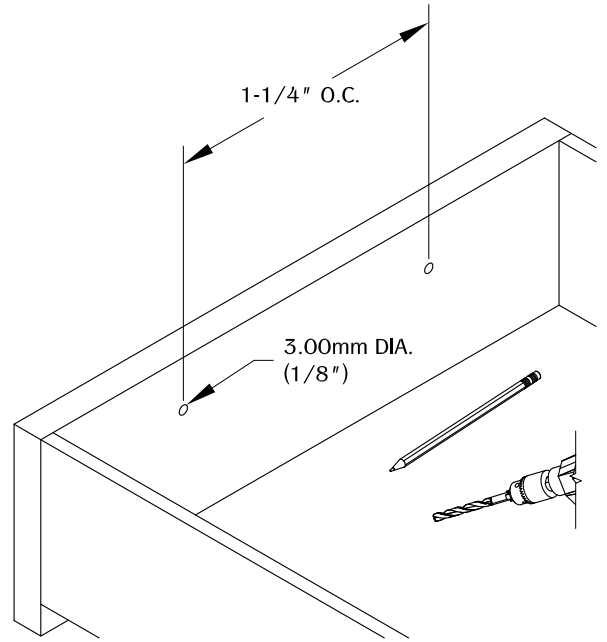

2

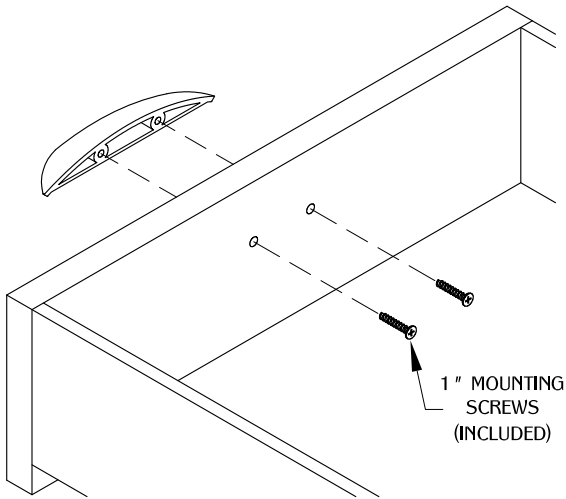

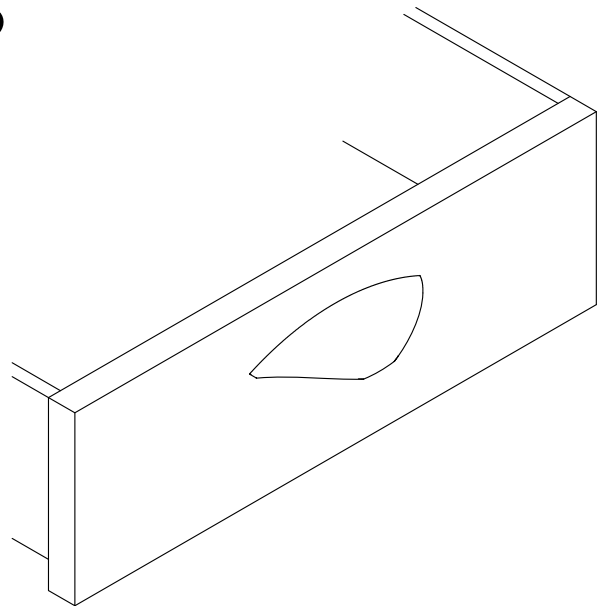

3



Note: Additional screw sizes available upon request (3/4" up to 2" in 1/4" increments).

NOTE:  
ALL DIMENSIONS HAVE A +/- 1/32" TOLERANCE.  
WE DO NOT RECOMMEND DRILLING OR CUTTING ANY HOLES BEFORE RECEIVING A PRODUCT OR A PRODUCT SAMPLE.

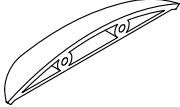
TABLE OF CONTENTS:

	..... 1x DP13
	..... 2x MOUNTING SCREWS