

FRONT VIEW

1

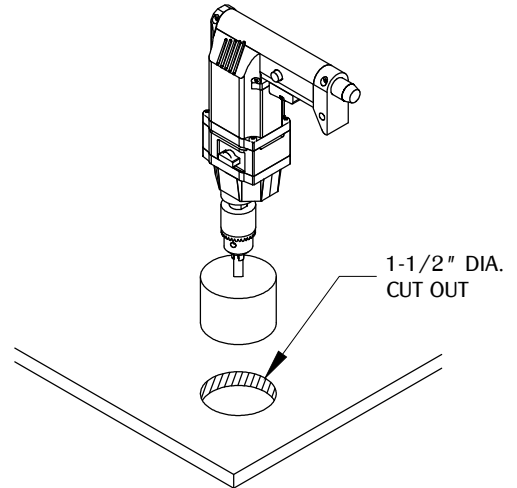

Make a cut out on the desired surface. (Note: We do not recommend cutting before receiving part or part sample.)

2

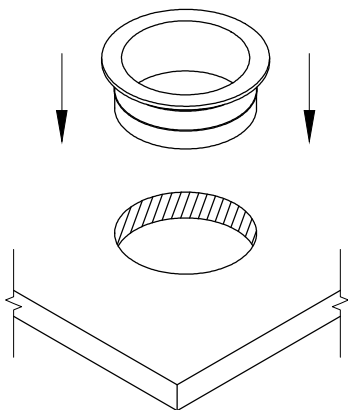

3

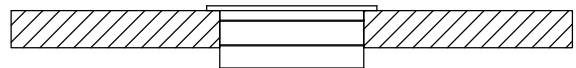

NOTE:

- All dimensions have a $\pm 1/32$ " tolerance. we do not recommend drilling or cutting any holes before receiving a product or a product sample.

TABLE OF CONTENTS:



..... 1x BG1