

1

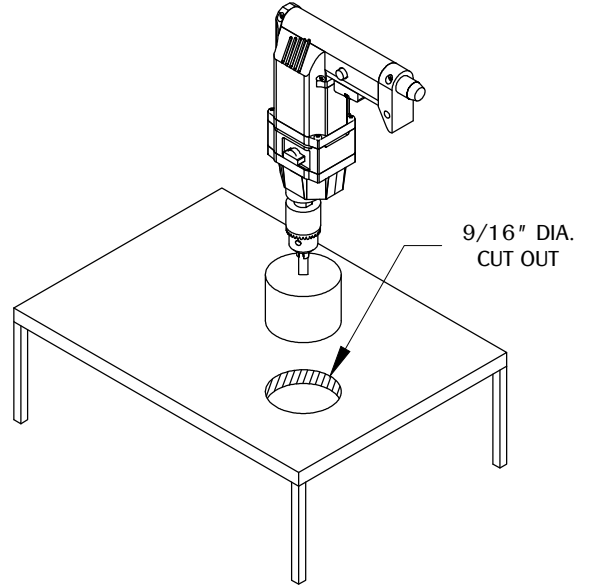

Make a cut out on the desired surface. (Note: We do not recommend cutting before receiving part or part sample.)

2

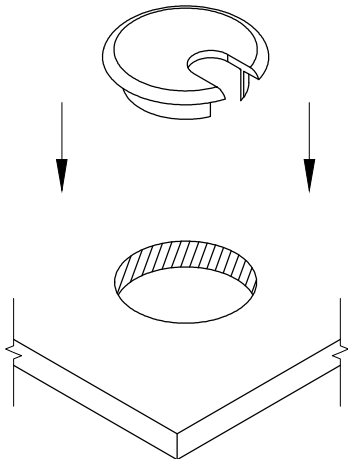

3



TABLE OF CONTENTS:



..... 1x AG2