

TOP VIEW

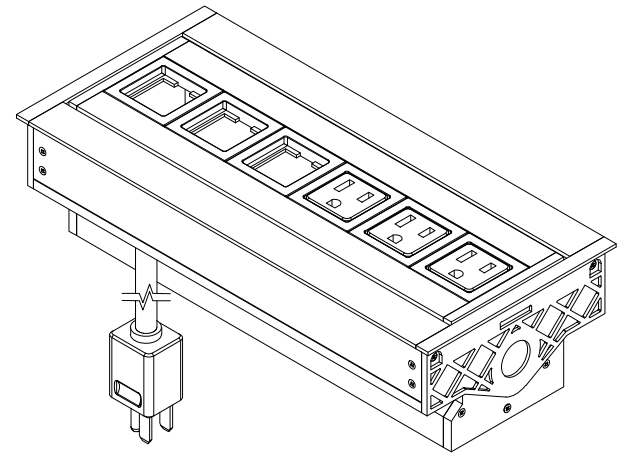

NOTE:

1. 6 ft. cord length.
2. Unit cavity is 2 5/8 X 9 1/4 X 1/2.
3. Table thickness is 3/4 MIN. to 1 11/16 MAX.
4. Plug dimension is 1 11/32 X 1 1/32 X 7/8.

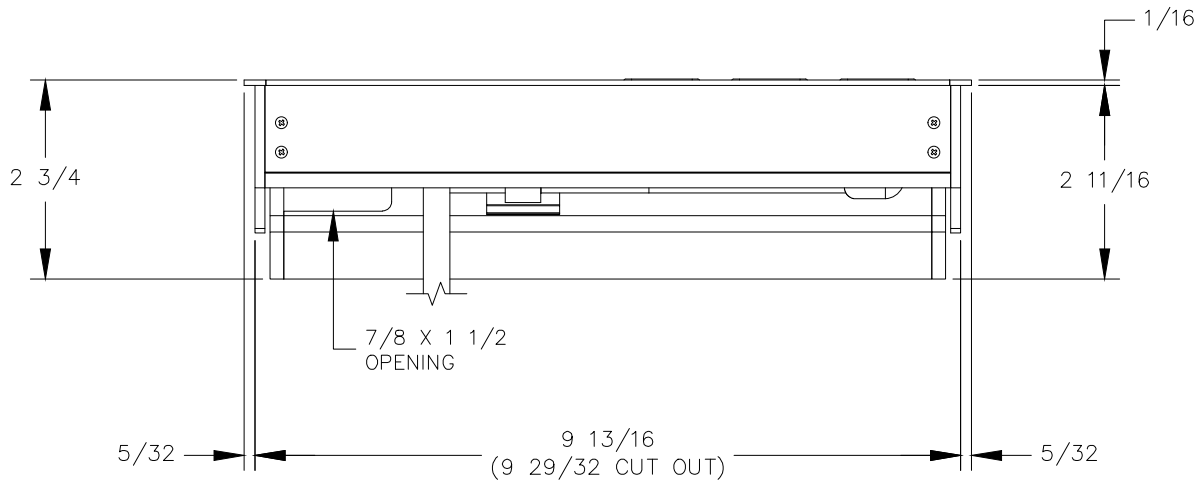

FRONT VIEW

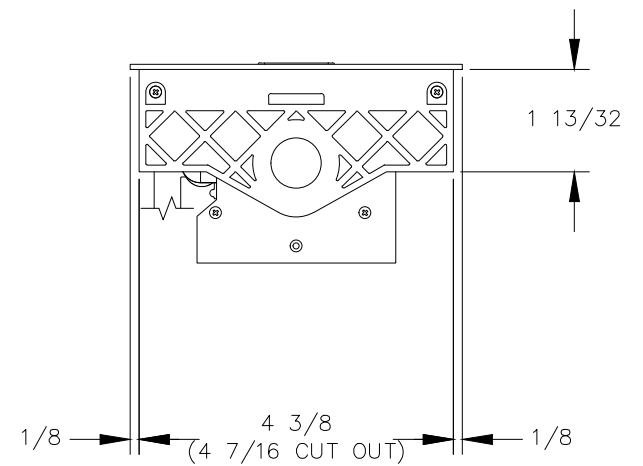

SIDE VIEW