

TOP VIEW

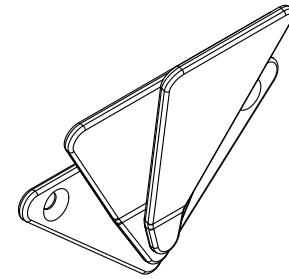

NOTE:

1. Weight capacity is 10 lbs.

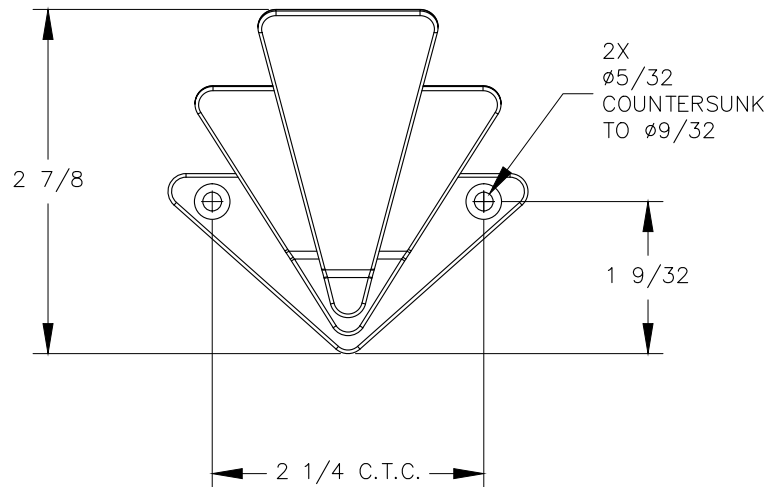

FRONT VIEW

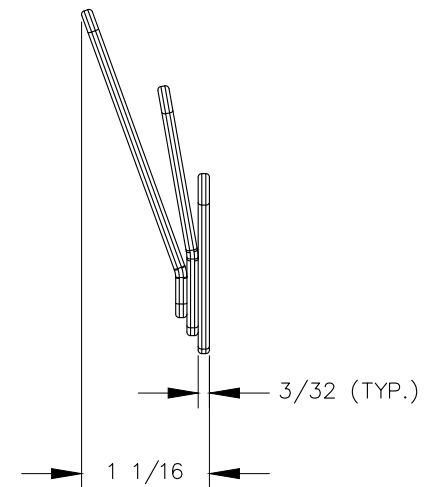

RIGHT VIEW