

PART#	(A) SQ.	(B) SQ. O.C.	(C) DIA.
TL34P-3	8"	6"	3"
TL34P-4	10"	8"	4"
TL34P-6	12"	10"	6"

NOTE:

- Weight capacity is 300 lbs. per leg.

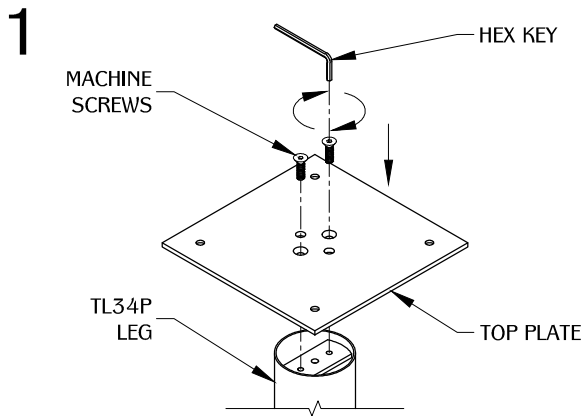

Install the top plate by using (2) flat head machine screws to secure on top of the leg.

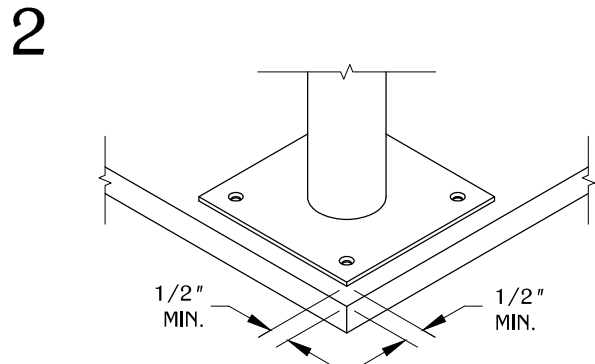

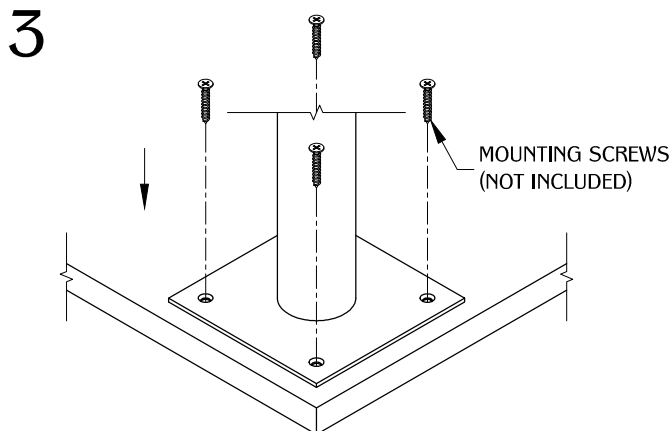

Determine the position and location of the part underneath the work surface. Place the part 1/2" minimum clearance from the edge of the work surface.

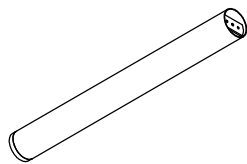

Use (4) flat head mounting screws to secure the part onto the work surface. (Note: Use appropriate screws and screw length depending on the table type and thickness.)

TABLE OF CONTENTS:

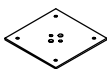
 1X TL34P LEG
 1X HEX KEY
 2X 7/8" 1/4- 20 THREAD MACHINE SCREWS
 1X TL-TOP PLATE