

MM4/SET

PROPRIETARY AND CONFIDENTIAL.
ALL DIMENSIONS HAVE A $\pm 1/32$ " TOLERANCE UNLESS OTHERWISE SPECIFIED. WE DO NOT RECOMMEND DRILLING OR CUTTING ANY HOLES BEFORE RECEIVING A PRODUCT OR A PRODUCT SAMPLE.

SPECIFICATIONS

- Maximum cord diameter is $5/8$ ".

TABLE OF CONTENTS



..... 1X MM4

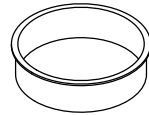

..... 1X MM4A

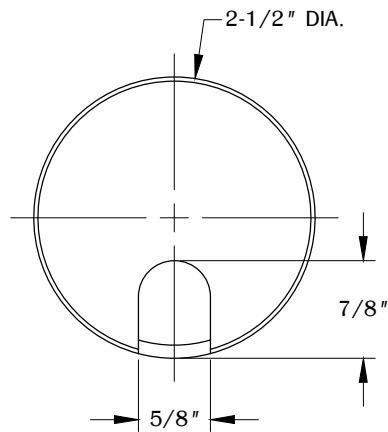
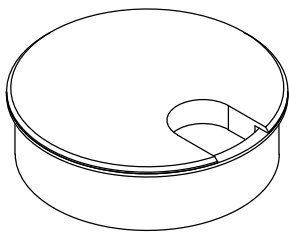

TOP VIEW

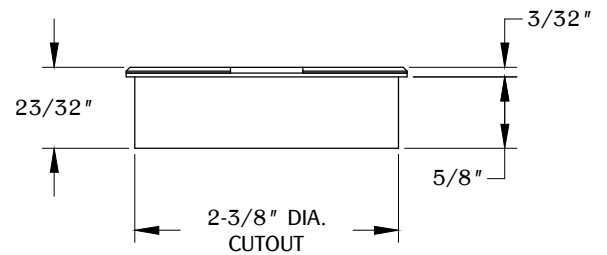

FRONT VIEW

1

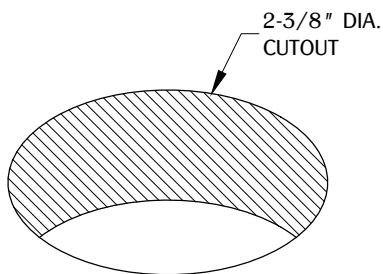

Make a cutout in the desired location on your work surface.
Allow enough clearance for part function.

2

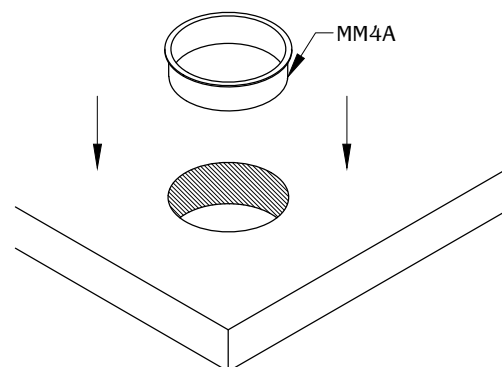

Install the MM4A into the cutout and make sure it is fully leveled onto the work surface.

MM4/SET

PROPRIETARY AND CONFIDENTIAL.
ALL DIMENSIONS HAVE A +/- 1/32" TOLERANCE UNLESS OTHERWISE SPECIFIED. WE DO NOT RECOMMEND DRILLING OR CUTTING ANY HOLES BEFORE RECEIVING A PRODUCT OR A PRODUCT SAMPLE.

3

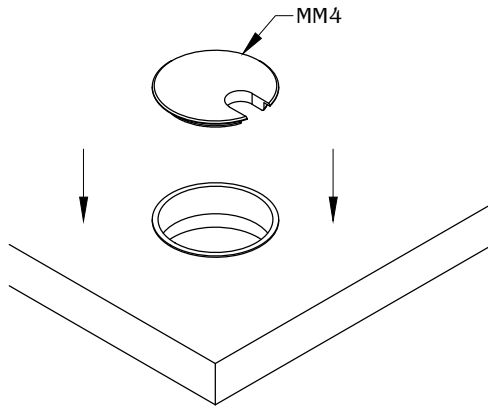

Insert MM4 into the MM4A.